

Important Safety Instructions

Please save these instructions for future use!



Read all of the instructions and cautions in the manual before beginning the installation !

■ Important Safety Instructions

- Installation and wiring must comply with the Local and National Electric Codes (NEC) and must be done by a certified technician.
- Do NOT disassemble or attempt to repair the inverter. There are no serviceable parts for this inverter.
- DO NOT parallel this device with other AC input sources to avoid damage.
- DO NOT attempt to touch the unit while it is operating as temperatures will be very hot. In addition, do not open the terminal cover while the unit is in operation.
- Make sure all connections going into and from the inverter are tight. There may be sparks when making connections, therefore, make sure there are not flammable materials or gases near installation.
- Installing breakers or fuses outside of the unit is recommended.
- After installation, check that all line connections are tight and secured.
- Do NOT let the positive (+) and negative (-) terminals of the battery touch each other. Use Lithium batteries or deep cycle Sealed Lead Acid, Flooded, Gel, AGM batteries.
- Explosive battery gases may be present while charging. Be certain there is enough ventilation to release the gases.
- Be careful when working with large lead acid batteries. Wear eye protection and have fresh water available in case there is contact with the battery acid.
- Over-charging and excessive gas precipitation may damage the battery plates and activate material shedding on them. Too high of an equalizing charge or too long of one may cause damage. Please carefully review the specific requirements of the battery used in the system.

Table of Contents

Important Safety Instructions	1
General Information	3
Key Features	3
Battery Charging Modes	4
Load Output Working Modes	7
Product Overview	8
Dimensions	9
Installation	10
Location Recommendations	10
Wiring	12
Battery Wiring.....	13
PV Wiring.....	14
AC Output Wiring.....	15
AC Input Wiring	16
Communication Ports	17
Dry Contacts.....	17
RS485	17
USB	17
Operation	18
LCD Operation.....	18
LCD Menu Screens	22
LCD Programmable Features	23
Electronic Protections	29
Fault Codes.....	30
Maintenance	31
Technical Specifications.....	32
Non-Lithium Battery Parameters.....	34
Lithium Battery Parameters	35
Charging Parameters Glossary	36

General Information

Pow series is a new hybrid solar charge inverter, which integrates solar energy storage & means charging energy storage and AC sine wave output. Thanks to DSP control and advanced control algorithm, it has high response speed, high reliability and high industrial standard. Four charging modes are optional, i.e. Only Solar, Mains Priority, Solar Priority and Mains & Solar hybrid charging; and two output modes are available, i.e. Inverter and Mains, to meet different application requirements. The solar charging module applies the latest optimized MPPT technology to quickly track the maximum power point of the PV array in any environment and obtain the maximum energy of the solar panel in real time.

Through a state of the art control algorithm, the AC-DC charging module realizes fully digital voltage and current double closed loop control, with high control precision in a small volume. Wide AC voltage input range and complete input/output protections are designed for stable and reliable battery charging and protection.

Based on full-digital intelligent design, the DC-AC inverter module employs advanced SPWM technology and outputs pure sine wave to convert DC into AC. It is ideal for AC loads such as household appliances, power tools, industrial equipment, and electronic audio and video equipment. The product comes with a segment LCD display design which allows real-time display of the operating data and status of the system. Comprehensive electronic protections keep the entire system safer and more stable.

■ Key Features

1. Full digital voltage and current double closed loop control, advanced SPWM technology, output of pure sine wave.
2. Two output modes: mains bypass and inverter output; uninterrupted power supply.
3. Available in 4 charging modes: Only Solar, Utility Priority, PV Priority, Utility & Solar hybrid charging.
4. Advanced MPPT technology with an efficiency of 99.9%.
5. Designed with a LCD screen and 3 LED indicators for dynamic display of system data and operating status.
6. Manual ON/OFF switch controlling AC output.
7. Power saving mode available to reduce empty load loss.
8. Intelligent variable speed fan to efficiently dissipate heat and extend system life.
9. Lithium battery activation by PV solar or mains, allowing access of lead-acid battery and lithium battery.
10. Complete protections, including short circuit protection, over voltage and under voltage protection, overload protection, reverse protection, etc.

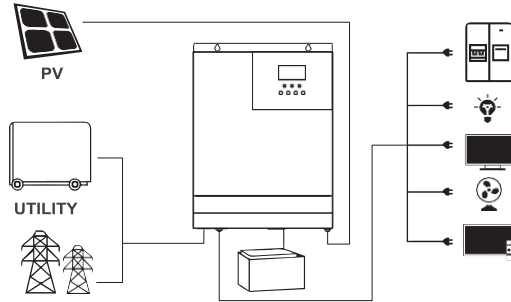

Photovoltaic Modules (PV): convert light energy into DC power, charge the battery through the solar inverter charger, or directly reverse into alternating current to power the load.

Power or generator (Utility): Access at the AC input can power the load and charge the battery. If you do not have a power supply or generator, the system can also operate normally, where the load is supplied by batteries and photovoltaic modules.

Battery: The role of the battery is to ensure the normal use of electricity for the system load when the solar energy is insufficient and there is no electricity.

Household load: Can be accessed to a variety of household and office loads, including refrigerators, lamps, televisions, fans, air conditioning and other AC loads.

■ Battery Charging Modes:

The solar inverter will have 4 operational charging modes which changes the logic as how and when to charge the battery banks. The solar inverter has four charging modes: PV priority, Utility Priority, Hybrid Charging, and Only Solar Charging.

PV Priority

In PV Priority mode it will make full use of the solar input during the day in order to charge the battery bank. This effectively allows using the unit off-grid during peak utility times in order to cut costs on utility charging. Only when solar fails to start or is interrupted will the unit automatically switch to utility mode for backup.



Utility Priority

In Utility Priority mode, the detected AC input will be priority for battery charging. If the power becomes unstable or unusable, then it will switch to PV charging.

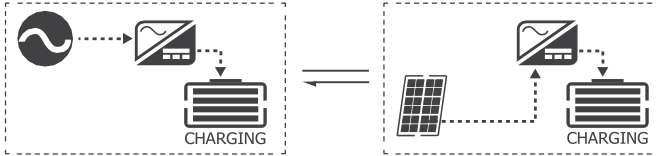

Hybrid Charging

In Hybrid Charging, PV and Utility will work together to charge the battery bank at the same time. Priority will be given to PV and utilize MPPT charging. Upon PV charging being insufficient, the power supply replenishes with Utility power. This method is the fastest to charge and suitable for unstable areas of the grid, ready to provide adequate backup power supply.

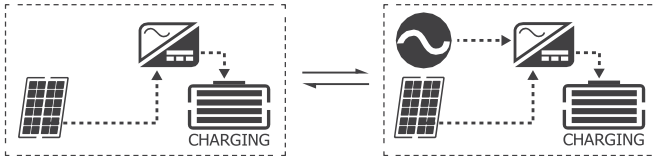

Only Solar Charging

Only solar charging is the most energy-efficient way to charge your battery bank and does not make use of AC input. Utility will not charge the battery, even if it is available.



■ Load Output Working Modes

The solar inverter has 3 working modes that dictate how the incoming power is used to power the loads. Users may configure the output source priority to configure load power.

PV Priority

In this mode only the incoming solar energy and battery power are used to power the loads. This can maximize the use of green energy when selecting PV priority in Battery Charging Mode to achieve overall energy conservation and emission reduction. Upon there being no more usable solar energy or the battery voltage drops to a low voltage setpoint, then the unit will switch to utility power to continue to power up the loads. It is recommended to be in this mode for relatively stable areas.

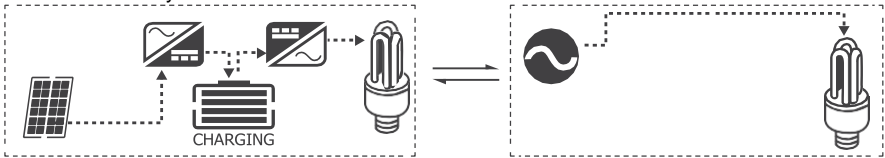

Utility Priority

Equivalent to a backup UPS for use in unstable areas of the grid, Utility will provide power to the loads as priority. Solar and battery energy will provide power to the loads only when utility power is not available.

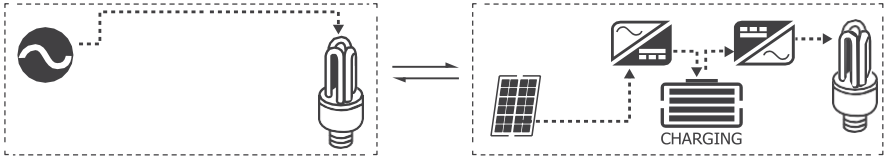

Inverter Mode

The Battery energy will supply power to the loads. Utility provides power to the loads only when battery voltage drops to low voltage which maximizes the use of DC power.

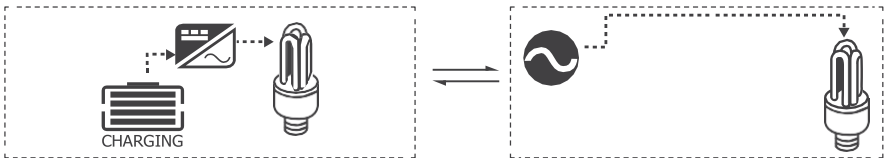

Product Overview

Identification of Parts

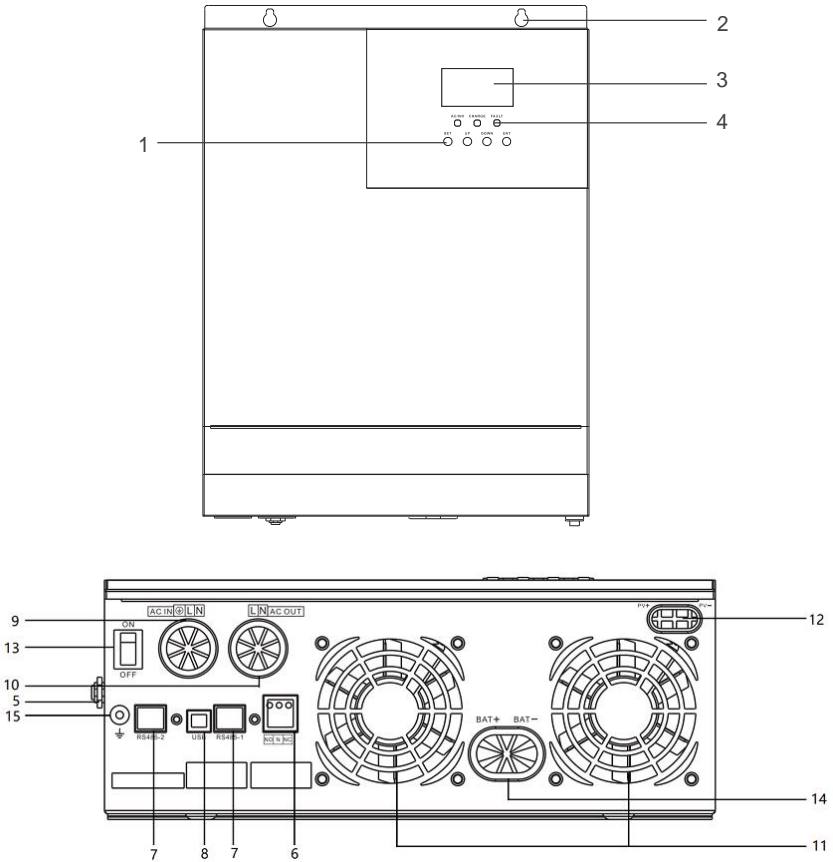

Key Parts

1	LCD Buttons	9	AC Input Terminal
2	Mounting Holes	10	AC Output Terminal
3	LCD Screen	11	Cooling Fans
4	LED Indicators	12	PV Input Terminal
5	AC Input Breaker	13	Main On/Off Power Switch
6	Dry Contact Port	14	Battery Input Terminal
7	RS485 Communication Port	15	Grounding Lug
8	USB Debugging Port (Internal Use)		

Dimensions

Identification of Parts

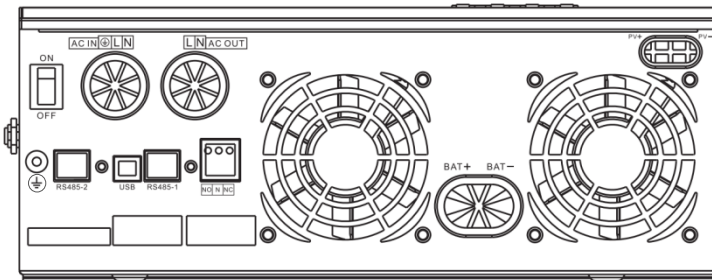
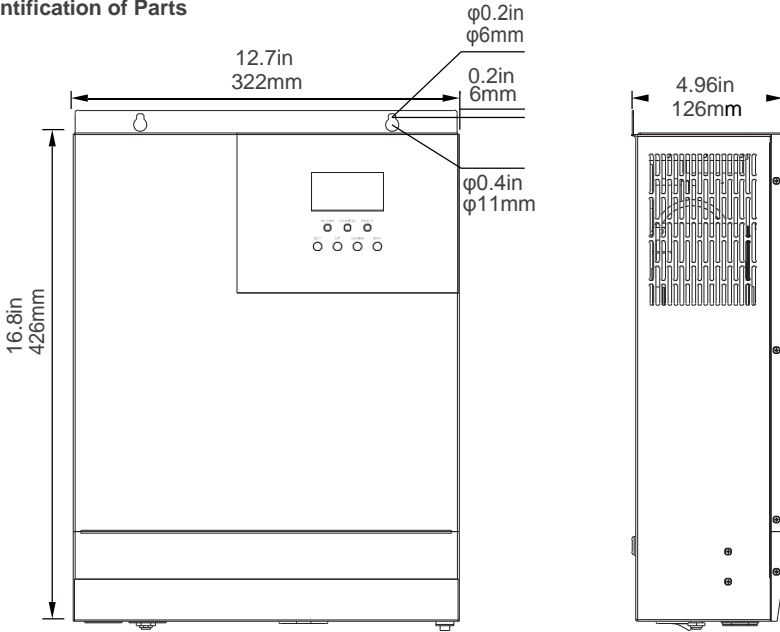

Installation

Please read this manual carefully and familiarize yourself with the installation procedures before installation.

■ Installation Safety



The unit should be installed in a well-ventilated, cool, and dry environment. Make sure the fans of the unit and the ventilation holes are not blocked.



Do not expose the unit to rain, moisture, snow, or liquids of any type.



Never install the inverter in a sealed enclosure with flooded batteries. Gas can accumulate and there is a risk of explosion.



Do not install the inverter in the same compartment as the battery bank because it could serve as a potential fire hazard.

■ Location Recommendations

Ensure installation follows the following guidelines:

1. **Cool, dry, well-ventilated area** — Heat is the worst enemy for electronic equipment. Inverters must be in an area where the fans are not blocked or where they are not exposed directly to the sun. They should be in an area free of any kind of moisture and allow for clearance of at least 8" around the unit to provide adequate ventilation.
2. **Protection against fire hazard** — the unit should be away from any flammable material, liquids, or any other combustible material. The unit can spark and the consequences could be severe.
3. **Close proximity to battery bank**—prevent excessive voltage drop by keeping the unit close to the battery bank and having a properly sized wire going from the battery bank to the inverter.
4. **Limiting electromagnetic interference (EMI)** — ensure the inverter is firmly grounded to a building, vehicle, or earth grounded. Keep the inverter away from EMI receptors such as TVs, radios, and other audio/visual electronics to prevent damage/interference to the equipment.



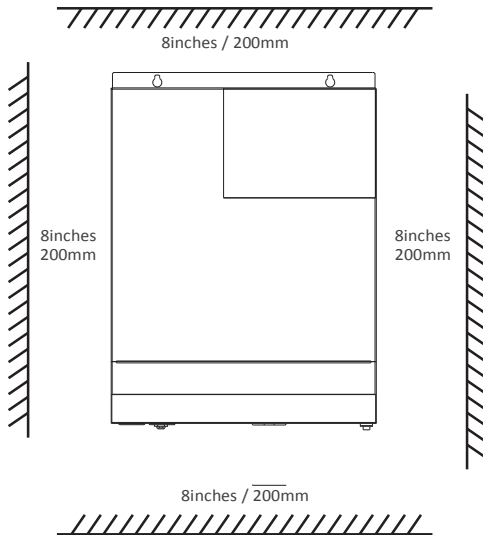

Other Precautions:

- When installing the battery, be very careful, when installing lead-acid liquid batteries, you should wear protective glasses, once in contact with battery acid, please wash with water in time.
- Avoid placing metal objects near the battery to prevent short circuits in the battery.
- Acid gas may be generated when the battery is charged so ensure good ventilation around the environment.
- Incorrect or improper connection points and corroded wires can cause great heat to melt the wire insulation, burning surrounding materials, and even cause fire, so ensure that the connection is tightened
- It is best to avoid mobile applications when the wire shakes and cause the connection head loose. Outdoor installation should avoid direct sunlight and rain, snow.
- Do not install the solar inverter in harsh environments such as damp, greasy, flammable and explosive areas or where dust accumulation is high.
- The municipal electrical input and AC output are high voltage, do not touch the wiring. Do not touch the unit when the fan is working.
- To avoid damage, do not use more than one (in parallel) input AC power supply.



Please Note: While the Solar inverter has fans for cooling, this installation location optimal for natural convection cooling will improve the overall efficiency .

■ Wiring

-  The PowMr Solar Inverter is suitable for 48V battery banks systems ONLY. Not following the minimum DC requirement may cause irreversible damage to the unit.
-  The solar inverter components at the AC input/output, battery components, and PV components will produce high energy output. Make sure to connect the appropriate component to the appropriate labeled terminals.
-  Be careful of the positive and negative poles. Reversing the poles may cause permanent damage to the inverter.
-  The input terminals of the inverters have large capacitors connected to them. Once a positive and negative wire are connected to the terminals, it will complete the circuit, and commence drawing a heavy current momentarily. As a result, there may be a sparking occurring even if the inverter is in the off position. To minimize sparking, it is recommended that the user have the appropriate size wire feeding into the solar inverters and/or install an external fuse leading into the inverter.
-  After the power switch is switched off, there is still high energy inside the solar inverter, do not open or touch the internal device, wait for the capacitance to be put off after the relevant operation.

Locate the power button on the solar inverter and make sure the solar inverter main power is turned off

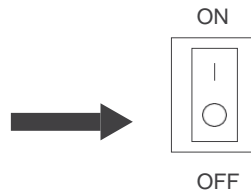

Remove the terminal cover by unscrewing the appropriate terminals located on the face of the solar inverter

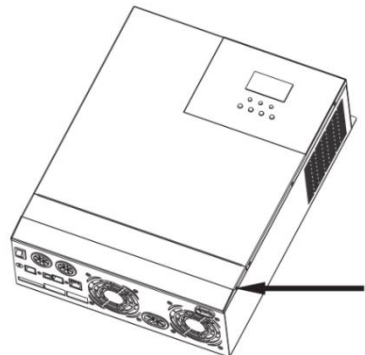

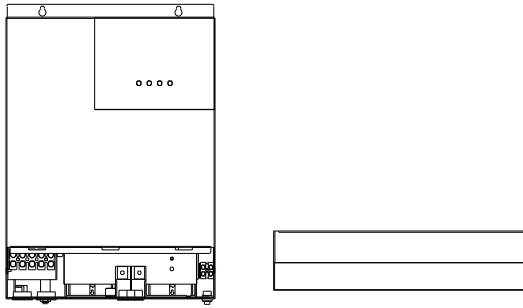

Wiring and installation methods must comply with national and local electrical specifications. The following chart is reference only. Longer wire runs between solar panels and the solar inverter as well as longer runs between the solar inverter and battery bank will require thicker wiring size to minimize loss and improve system performance.

Specification	Minimum Recommended Wiring AWG	Max Amps
Battery Wiring	2AWG	120A
PV Wiring*	10AWG	16A
AC Input Wiring	7AWG	63A
AC Output Wiring	7AWG	63A

■ Battery Wiring

- ⚠ Be careful of the positive and negative poles. Reversing the poles may cause permanent damage to the inverter.
- ⚠ The input terminals of the inverters have large capacitors connected to them. Once a positive and negative wire are connected to the terminals, it will complete the circuit, and commence drawing a heavy current momentarily. As a result, there may be a sparking occurring even if the inverter is in the off position. To minimize sparking, it is recommended that the user have the appropriate size wire feeding into the solar inverters and/or install an external fuse leading into the inverter.

Rated Battery Discharge Current	Maximum Battery Charging Current	Recommended Wiring	Recommended Circuit Breaker	Recommended Ring Terminal
125 A	80A	2AWG	2 pole, 200A	5/16"

- ⚠ Make sure any circuit breakers are disconnected and ensure the unit is in the off position.

The solar inverter takes a 48V battery input to operate. This will require combining 12V or 6V batteries in series to achieve the minimum voltage DC requirement. It is recommended to use battery cables with ring terminals. The ring terminals must be firmly tightened and secured on the respective battery terminals to prevent any excessive heating or resistance. Connect the positive and negative battery ring terminals to the respective positive and negative battery terminals on the solar inverter.

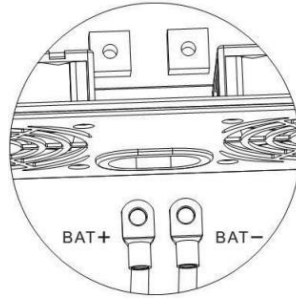

■ PV Wiring

Maximum PV Charging Current	Recommended Wiring	Recommended Circuit Breaker	Recommended Wiring
16A	10AWG	2 pole, 25A	Bare Wire



For PV to charge 48V battery banks, you will need a minimum PV Voc voltage of 120VDC.

When combining panels in parallel it is recommended to use a combiner box for safety and organizational precautions. The solar inverter accepts a maximum of 500VDC input and requires a 48V battery input to operate. This will require combining solar panels in series or series parallel to achieve the minimum voltage DC requirement. Due to many factors affecting PV performance, it is recommended to utilize the open circuit voltage (Voc) when connecting panels in series to make sure you stay under the 450VDC input. For parallel connections, it is recommended to use the short circuit current (Isc) to make sure you are well under the 16A limit.

The bare wire terminal blocks must be firmly tightened and secured to prevent any excessive heating or resistance. Connect the positive and negative PV wire to the respective positive and negative PV terminal block on the solar inverter.

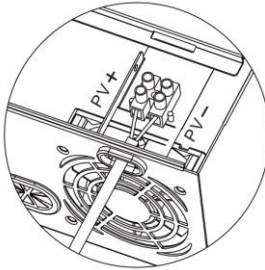

■ AC Output Wiring

- ⚠ Only the Live and Neutral wires will be connected to the Output Terminal Block, the Ground will be connected to the screw terminal.
- ⚠ Make sure any circuit breakers are disconnected and ensure the unit is in the off position.
- ⚠ AC Output should NEVER be connected to public power/utility or a generator.
- ⚠ There are two terminal blocks with “IN” and “OUT” markings. Please do NOT misconnect input and output connectors.

Maximum Inverter Bypass Current	Recommended Wiring	Recommended Circuit Breaker
63A	7AWG	2 pole, 63A

Carefully place the correct AC wire into the respective AC Output terminal block. The ground output cable will need to be connected to the ground screw terminal located separately from the output terminal block. It is recommended to keep ground as close as possible to the solar inverter charger, the shorter the ground wire, the better. The order should be as follows:

⊕ : Ground | L: Live | N: Neutral

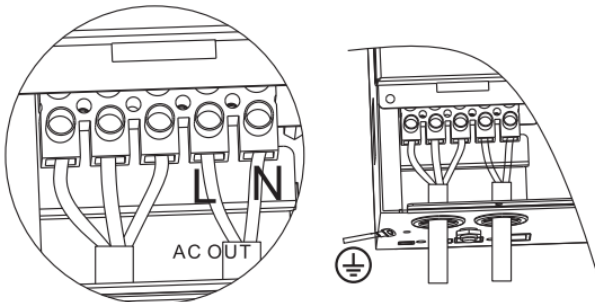

■ AC Input Wiring

- ⚠ The AC input must never be connected to the AC output as irreversible overload or damage may result
- ⚠ The AC Input Terminal Block is connected to circuit breakers for added protection. Do not modify or alter them as it may cause irreversible damage to the solar inverter.
- ⚠ There are two terminal blocks with “IN” and “OUT” markings. Please do NOT mis-connect input and output connectors.

Run the AC input line through the AC input cable entry slot. Make sure to use appropriate cable sizing when working with AC. Carefully place the correct AC wire into the respective AC Input terminal block. The order should be as follows:

⊕ : Ground | L: Live | N: Neutral

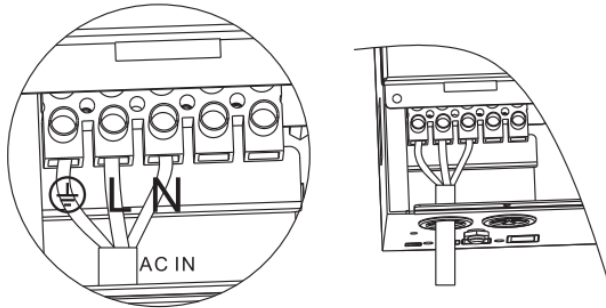

Communication Ports

■ Dry Contacts

- ⚠ To use this to function, an auto start controller must be installed on the generator. there are three contacts; up to down: NO, N, NC
- ⚠ Do not store units with auto gen start feature enabled. Generators exhaust dangerous fumes when running.

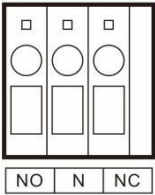

This contact automatically starts the generator and charges the battery bank. Under normal conditions, this terminal is NC-N point closed, NO-N point open. When the battery voltage reaches the low voltage point, the relay coil is energized, and NO-N point now is closed and NC-N point now is open.

⚠ the NO-N contact can drive the resistive load of 125VAC/1A, 30DCV/1A

⚠ While the generator is connected, the unit now operates in “Charging Mode” with the AC power from the Generator charging the batteries as well as providing power to the AC loads.

■ RS485

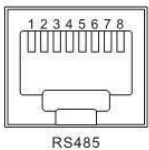

There are two communication ports RS485-1 and RS485-2 and also two functions:

- ① RS485 communication with lithium battery BMS can be conducted directly through this port RS485-2 (need to be customized);
- ② RS485-1 is connected to the selected RS485 to WiFi /GPRS communication module independently developed by our company After the selected module is equipped, the reverse control all-in-one machine of our company can be connected through mobile APP, and the operating parameters and status of the reverse control all-in-one machine can be checked through the mobile APP.
- ③ Such as shown in the figure: pin 1 is 5V power supply; pin 2 is GND, pin 7 is RS485-A and pin 8 is RS485-B. port will be used for connecting to the BT-2 Accessory for

■ **USB** The USB port is for internal purposes only. It will not be supported as it requires proprietary information.

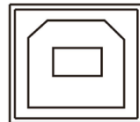

⚠ When using both USB and RS485, you can only use one of two alternatives, not use both simultaneously .

Operation

Assuming all connections are correct and tightly secured, Locate the power button on the solar inverter and turn the main power switch to the ON position.

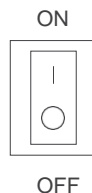

The following describes the basic operation of the solar inverter charger

■ LCD Operation

The solar inverter is equipped with 3 LCD indicators and 4 working buttons

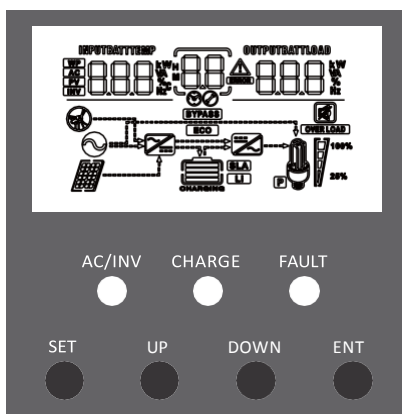





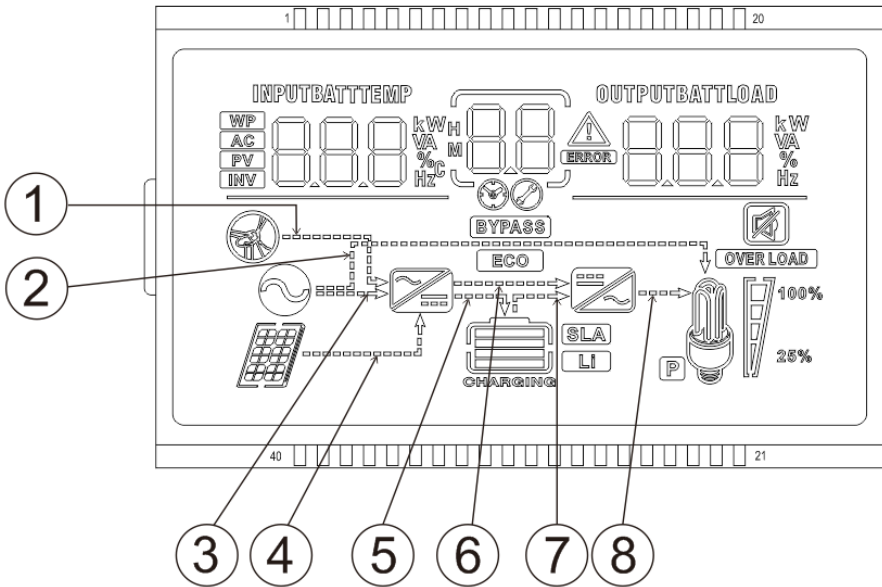





















LED	Color	Behavior	Parameter
AC/INV	Yellow	Solid	mains supply output
		Flash	inverter output
CHARGE	Green	Flash	Battery is charging
		Solid	Battery is fully charged
FAULT	Red	Solid / Flash	System fault

Key	Parameter
SET	Go to / Exit Settings menu
UP	Previous selection
DOWN	Next choice
ENT	Under the Settings menu, determine/enter options



①	The arrow only displays during startup and not part of the solar inverter functionality	⑤	Indicates that the charging circuit is charging the battery
②	Indicates that the utility/grid is powering the load	⑥	The arrow only displays during startup and not part of the solar inverter functionality
③	Indicates that the power utility/grid is powering the battery charging circuit (AC-DC)	⑦	Indicates that the battery is powering the inverter circuit (DC-AC)
④	Indicates solar (PV) power to the battery charging circuit (DC-DC)	⑧	Indicates that the inverter circuit is powering the load

Icon	Function	Icon	Function
	Indicates that the AC input is connected to AC Source		Indicates that the inverter mode circuit is working
	The icon is not displayed		Indicates that the solar inverter charger is in the power bypass (Bypass)
	Indicates that the PV input is connected		Indicating that AC output is in overload state
	Indicates that the solar inverter charger is connected to the battery. Status:  0%~24%,  25%~49%,  50%~74%,  75%~100%	    	Indicates load percentage in 25% increments from the overall wattage of the solar inverter charger 0%~24%, 25%~49%, 50%~74%, ≥75%
	Indicates that the current battery type of the solar inverter charger is lithium		Indicates that the buzzer is not enabled
	Indicates that the current battery type of the solar inverter charger is a sealed lead acid		Indicates that an alarm has occurred on the solar inverter charger
	Indicates that the battery is charging		Indicates that the solar inverter charger is in a faulty state
	Indicates AC/PV charging circuit is working		Indicates that the solar inverter charger is in set mode
	AC Load voltage output		When not in setting mode displays alarm or fault code 2. In setting mode, displaying code of parameter item under current setting.

The following is on the left side of the LCD



Indicates AC input



Indicates PV input



Indicates inverter circuit



The icon is not displayed



Shows battery voltage, total battery charge current, charge power, AC input voltage, AC input frequency, PV Input voltage, internal heat sink temperature, and software version

The following is on the right side of the LCD



Indicates output voltage, output current, output power, output visual power, battery discharge current, software version. In this setting mode, the settings under the currently set parameter item code are displayed

■ LCD Menu Screens

On the LCD home screen, press the "UP" and "DOWN" buttons to turn the page to view the solar inverter's real-time data.

1	Battery Input Voltage	Fault code	Load Output Voltage
2	PV Temperature		PV Output Kilowatts
3	PV Input Voltage		PV Output Current
4	Battery Input Current		Battery Output Current
5	Battery Input Kilowatts		Battery Output Kilowatts
6	AC Input Frequency		AC Output Load Frequency
7	AC Input Voltage		AC Output Load Current
8	Internal Parameters		Load Output KVA
9	Inverter Temperature		Inverter Output Load Kilowatts
10	APP Software Version		Bootloader Software Version
11	Model PV Voltage Rating		Model PV Power Rating
12	Model Battery Voltage Rating		Model Output Current Rating

LCD Programmable Features

Press the "SET" key to enter parameter setting mode. After entering the settings menu, the parameter number 00 flashes and you can press the "UP" and "DOWN" keys to select the parameter code that you want to set. To access the parameter program press "ENT" key to enter the parameter editing state, at which point the value of the parameter flashes. Adjusts the value of the parameter through the "UP" and "DOWN" buttons, and finally press "ENT" to press the key, complete the edit of the parameter, and return to the parameter selection state.

Parameters Number	Parameter Name	Set options	Description
00	Exit	[00] ESC	Exit the settings menu
01	Load Working Mode	[01] SOL	Solar energy provides power to the loads as priority. If solar energy is not enough to power all connected loads, battery energy will supply power the loads at the same time. Utility provides power to the loads only when any one condition happens: Solar energy is not available Battery voltage drops to low-level set-point in Program [04]
		[01] UTI (Default)	Utility will provide power to the loads as priority. Solar and battery energy will provide power to the loads only when utility power is not available
		[01] SBU	Solar energy provides power to the loads as priority. If solar energy is not enough to power all connected loads, battery energy will supply power to the loads at the same time. Utility provides power to the loads only when battery voltage drops to low-level set-point in Program [04]
02	Output Frequency	[02] 50.0	The output frequency can be set through this menu. By default, the value should be 60Hz
		[02] 60.0 (Default)	
03	AC Input Voltage Range	[03] APL	By default, the input voltage range is the same, 90~140VAC
		[03] UPS (Default)	By default, the input voltage range is the same, 90~140VAC

Parameters Number	Parameter Name	Set options	Description
04	Battery Power to Utility Setpoint	46.0V (Default)	Setting voltage point back to utility source when selecting “SBU” or “SOL” in program [01] . When the voltage of the battery is lower than this setting, the output switches from inverting to the utility. The setting range is from 44V - 52V, in 0.4V increments.
05	Utility to Battery Power setpoint	[05] 56.0V (Default)	Setting voltage point back to battery mode when selecting “SBU” or “SOL” in program [01] . When the battery voltage is higher than the setting value, the output is switched from the utility to the battery mode. The setting range is 48V - 60V, in 0.4V increments. *Cannot be higher than [09]
06	Battery Charging Mode (Please Note: If this inverter/charger is working in Battery mode or Power saving mode, only solar energy can charge battery. Solar energy will charge battery if it's available and enough)	[06]CSO	Solar energy will charge battery as priority. Utility will charge battery only when solar energy is not available
		[06] CUB	Utility will charge battery as priority. Solar energy will charge battery only when utility power is not available
		[06] SNU (Default)	Solar energy and utility will charge battery at the same time. MPPT Solar energy will be priority charging and when it is insufficient, Utility will become priority. When the photovoltaic energy is sufficient again, Utility will stop charging
		[06] OSO	Solar energy will be the only charging source even if utility is available
07	Maximum charging current (Max. charging current = utility charging current + solar charging current)	[07] 60A (Default)	The maximum solar charging is 80A, the maximum Grid/Utility charging is 40A (adjustable in Program 28), totaling the maximum current of 80A. The range can be configured between 0 ~ 80A

Parameters Number	Parameter Name	Set options	Description
08	Battery type	[08] USE	User-defined, all battery parameters can be set
		[08] SLD (Default)	Sealed lead-acid/AGM battery, constant voltage charging 57.6V, float charging voltage 55.2V
		[08] FLD	Flooded lead-acid battery, constant voltage charging 58.4V, float charging voltage 55.2V
		[08] GEL	Gel lead-acid battery, constant voltage charging 56.8V, float charging voltage 55.2V
		[08] LF14 LF15 LF16	Lithium iron phosphate battery corresponding to 14 strings, 15 strings and 16 strings Default constant voltage charging voltage strings: 49.6V strings: 53.2V strings: 56.8V
[08] N13 N14	Ternary lithium battery, which is adjustable.		
09 *available in USER and lithium setting only	Boost Charge Voltage	[09]57.6 (Default)	Changes the charging voltage setting, set the range 48V to 58.4V, in 0.4V increments
10 *available in USER setting only	Boost Charge Duration	[10] 120 min (Default)	Raise the boost charge time setting, refers to the constant voltage charging reached at Program [09] . The range is 5min to 900min, in 5 minute increments
11 *available in USER setting only	Float Charge Voltage	[11] 55.2V (Default)	Floating charging voltage set range 48V to 58.4V, in 0.4V increments

Parameters Number	Parameter Name	Set options	Description
12 *available in USER and lithium setting only	Low Voltage Load Disconnect	[12] 42V (Default)	It is recommended to set this voltage below the maximum voltage the battery can withstand. When this voltage is reached, the loads will be powered off after a time delay adjustable in Program [13] The range is 40V to 48V, in 0.4V increments
13 *available in USER and lithium setting only	Battery Over-discharged Delay Time (If a power shortage occurs and recovers in a short time, it can cause damage to your connected appliances. To prevent this kind of damage, please check manufacturer if heavy load appliances are equipped with time-delay function before installation)	[13] 5S (Default)	The following parameter sets the delay-time after the battery voltage is below the set-point in Program [12]. The set range is 5-50 seconds, in 5s increments
14 *available in USER and lithium setting only	Battery Undervoltage Alarm	[14] 44V (Default)	Warning that the battery is approaching low voltage. The output does not shut down and the range is 40V to 52V, in 0.4V increments
15 *available in USER and lithium setting only	Battery Discharge Limit Voltage	[15] 40V (Default)	When the battery voltage goes below this voltage set-point, the solar inverter will immediately disconnect and shut down immediately. The set range is 36V to 50V, in 0.4V increments
16 *available in FLD and USER setting only	Set Equalization charging	[16] DIS	No equalization charging
		[16] ENA (Default)	Enables equalization charging
17 *available in FLD and USER setting only	Battery Equalization Voltage	[17] 58.4V (Default)	Set equalization charging voltage. The range is 48V to 58.4V, in 0.4V increments

Parameters Number	Parameter Name	Set options	Description
18 *available in FLD and USER setting only	Battery Equalization Duration	[18] 120min (Default)	Setting range is from 5min to 900 min. , in 5min increments
19 *available in FLD and USER setting only	Battery Equalization Time-Delay	[19] 120min (Default)	Setting range is from 5min to 900 min, in 5min increments
20 *available in FLD and USER setting only	Equalization interval	[20] 30 days (Default)	Setting range is from 0 days to 30 days, in 1 day increments
21 *available in FLD and USER setting only	Enable Equalization Immediately	[21] DIS (Default)	Stops equalization charging immediately
		[21] ENA	Starts Equalization charging immediately
22 *Power-saving Mode (ECO Mode)	Power-saving Mode	[22] DIS (Default)	Disables power-saving mode
		[22] ENA	After enabling the energy-saving mode, in case of empty or small load, the output is turned off after output delaying of inverter for a certain period of time. After the rocker switch is pressed to “OFF” state and then to “ON” state, the inverter restore the output.
23	Overload auto-start	[23] DIS	Overload automatic restart is disabled, and the unit will not turn on the loads
		[23] ENA (Default)	Enables automatic restart if the load shutdown output has occurred. The unit attempts to restart the output after 3 minutes and After 5 attempts the unit will not longer resume to turn on the loads
24	Overtemperature auto-start	[24] DIS	Over-temperature automatic re-start is disabled
		[24] ENA (Default)	The over-temperature protection is activated and upon temperature dropping, the unit automatically restarts

Parameters Number	Parameter Name	Set options	Description
25	Buzzer alarm	[25] DIS	No alarm
		[25] ENA (Default)	Enable alarm
26	Alarm	[26] DIS	No alarm prompts when the status of the primary input source changes
		[26] ENA (Default)	Enable alarm prompts when the status of the primary input source changes
27	Overload bypass: When enabled, the unit will transfer to line mode if overload occurs in battery mode.	[27] DIS	When disabled, the unit will not transfer to Utility mode
		[27] ENA (Default)	When enabled, the unit will transfer to Utility mode if overload occurs in battery mode.
28	Maximum AC Charging Current	[28] 40A (Default)	The range can be configured between 0-40A
29	Split Phase	[29] DIS (Default)	Supply for industrial frequency transformer (disabled)
		[29] ENA	Supply for industrial frequency transformer (enabled)
30	RS485 address setting	[30] 1 default	RS485 communication address setting range 1 ~ 254, (refer to Number [32] is valid when set as SLA)
35	Low Voltage Disconnect Recover	[35] 50.4V (Default)	Set point that recovers and reconnects the solar inverter from being disconnected in Low Voltage Disconnect. The range is from 44V -58.4V, in 0.4V increments.
37	Battery Charging Boost Return Setpoint	[37] 52V (Default)	When the battery reached at floating status, it will need to be lower than this setpoint before it starts charging. The range is the (Undervoltage Warning) ~ (Floating Voltage – 1.2V) for the respective battery
38	AC output voltage setting	[38] 120Vac default	Settable : (100/105/110Vac)

Electronic Protections

Number	Protection	Description
1	PV Current/Power Limiting Protection	When the configured PV array charge current exceeds the PV rated current, it will be charged at the rated current
2	PV Night anti-charge protection	At night, the battery is prevented from discharging through the PV component because the voltage of the battery is greater than the voltage of the PV component
3	Overvoltage Protection	Triggered when AC Input voltage reaches 140V
4	Power Input Under-voltage Protection	When utility input is below 90VAC, charging is stopped and the solar inverter is in inverter mode
5	Battery Over-voltage Protection	When the battery voltage reaches the overvoltage disconnect point, the PV and the utility automatically stop charging the battery, preventing damage from overcharging the battery
6	Battery low-voltage protection	When the battery voltage reaches the low voltage disconnect voltage point, the battery discharge is automatically stopped to prevent excessive discharge of the battery from being damaged
7	Load output short-circuit protection	When a short-circuit fault occurs at the load output, the output AC voltage is immediately turned off and outputs again after 1sec, for 3 more attempts. If they fail, then the unit will need to be manually powered on
8	Over-temperature protection	When the internal temperature of the unit is too high, the it will stop charging and discharging
9	Overload protection	Output again after 3 minutes after overload protection, overload 5 times in a row until the solar inverter charger is powered back, with A table of technical parameters after reference to the load level and duration of the manual
10	PV reverse polarity	Protection against reversing PV input connection
11	Bypass Protection protection	Prevents battery power mode from inverting when bypass is active
12	Bypass Flow Protection	Built-in AC input overcurrent protection circuit breaker
13	Battery input overcurrent protection	When the battery discharge output current is greater than the maximum and lasts 1 minute, the AC input is loaded
14	Battery input protection	When the battery is reversed or the inverter is shorted inside, the internal battery input fuse of the inverter fuses to prevent battery damage or fire
15	Charge short-circuit protection	The inverter protects and stops when the external battery port is shorted while the PV or AC is charging stop the output current

Fault Codes

Fault code	Fault name	Description
【01】	BatVoltLow	Battery under-voltage alert
【02】	BatOverCurrSw	Battery discharge current software protection
【03】	BatOpen	Battery not detected
【04】	BatLowEod	Battery undervoltage stopdischarge alarm
【05】	BatOverCurrHw	Battery overcurrent hardware protection
【06】	BatOverVolt	Charge overvoltage protection
【07】	BusOverVoltHw	Bus overvoltage hardware protection
【08】	BusOverVoltSw	Bus overvoltage software protection
【09】	PvVoltHigh	PV overvoltage protection
【10】	PvBuckOCSw	Buck Overcurrent Software Protection
【11】	PvBuckOCHw	Buck Overcurrent Hardware Protection
【12】	bLineLoss	utility power down
【13】	OverloadBypass	Side-by-side load protection
【14】	OverloadInverter	inverter overload protection
【15】	AcOverCurrHw	Inverted overcurrent hardware protection
【17】	InvShort	Inverter short-circuit protection
【19】	OverTemperMppt	Controller overtemperature protection
【20】	OverTemperInv	inverter over temperature protection
【21】	FanFail	Fan failure
【22】	EEPROM	Memory failure
【23】	ModelNumErr	Model settings are wrong
【26】	RlyShort	Error between AC output and bypass
【29】	BusVoltLow	Internal battery boost circuit failure

Fault	Solutions
Screen not displaying	Make sure the battery is properly connected and charged to be able to recognize the solar inverter. or click any button on the screen to exit screen sleep mode.
Rechargeable battery overvoltage protection	Measure whether the battery voltage exceeds 60V and disconnect the photovoltaic array from and the power-on.
Battery undervoltage protection	Wait until the battery is charged to return to above the low voltage recovery voltage.
Fan failure	Check that the fan is not turning or is blocked by something else.
Over-temperature Protection	When the temperature of the equipment cools to, normal charge and discharge control is restored.
Overload Protection	(1) Reduce the use of electrical equipment;(2) restart the solar inverter charger and load recovery output.
Inverter short-circuit protection	Disconnect or reduce any loads from the unit. Shut down the solar inverter charger and turn on again to clear the error.
PV overvoltage	Check with the meter if the PV input voltage is above the maximum allowable input voltage of 145 V operating voltage.
Battery missed alert	Check that the battery is not connected or that the battery side circuit breaker is not closed.

Maintenance

In order to maintain optimal long-term performance, it is recommended to perform inspections of the following items twice a year.

1. Make sure that the air flow around the solar inverter is not blocked and remove any dirt or debris from the radiator.
2. Check all terminals to see if there is corrosion, insulation damage, high temperature or combustion / discoloration signs, tighten the terminal screws.



Danger of electric shock! Make sure that all power supplies on solar inverter disconnected and that all capacitive power is released before checking or operating accordingly!

Technical Specifications

Model	POW-LVM5.0K-48V-H
Utility/Grid	
Rated input Voltage	110/120Vac
Input voltage range	(90Vac~140Vac) $\pm 2\%$
Frequency	50Hz/ 60Hz (auto detect)
Frequency range	47 \pm 0.3Hz ~ 55 \pm 0.3Hz (50Hz); 57 \pm 0.3Hz ~ 65 \pm 0.3Hz (60Hz);
Overload / Short circuit Protection	Breaker
Efficiency	>95%
Conversion time (Bypass and reverse)	10ms
Reverse Flow Protection	Yes
Max Bypass Current load	63A
Inverter	
Waveform	Pure Sine Wave
Rated Output (VA)	5000(4100/4300/4500)
Rated Output (W)	5000(4100/4300/4500)
Power factor	1
Output AC Voltage	120Vac(100/105/110Vac Settable)
Unstable Input Error	$\pm 5\%$
Output Frequency (Hz)	50Hz ± 0.3 Hz 60Hz ± 0.3 Hz
Efficiency	>90%
Overload protection	(102%<load<110%) $\pm 10\%$: reporting error and turn off the output after 5 minutes; (110%<load<125%) $\pm 10\%$: reporting error and turn off the output after 10 seconds; Load>125% $\pm 10\%$: reporting error and turn off the output after 5 seconds;
Peak power	7000VA
Motor Capability	3HP
Output Short-circuit Protection	Breaker
Bypass Breaker Specifications	63A
Rated Battery Voltage	48V (minimum start-up voltage 44V)
Battery voltage range	40.0Vdc~60Vdc ± 0.6 Vdc
Power Saving Mode Self-Consumption	≤ 50 W

Model	POW-LVM5.0K-48V-H
Utility/Grid Charging	
Battery type	Lead Acid or Lithium
Maximum Charging Current (AC)	40A
Unstable Condition Error	± 5A _{dc}
Charging Voltage Range	40 –60V _{dc}
Short-circuit protection	Breakers and blown fuses
Circuit Breaker Specifications	63A
Overcharge Protection	Yes; Automatically alerts and then turns off charging after 1 minute
Solar (PV) Charging	
Recommended PV Max	500V _{dc}
PV Operating Voltage	120-500V _{dc}
MPPT Voltage Range	120-450V _{dc}
Battery Charging Range	40-60V _{dc}
Maximum Input Power	5000W
Maximum Input Current	80A
Maximum Output Power	5000W
PV Charging Current Range	0-80A
Short-circuit Protection	Internal Fuse
Wiring Protection	Reverse Polarity
General	
Certifications	CE(IEC62109), RoHS, EN61000
Operating Temperature	5°F ~ 131°F/ -15°C ~ 55°C
Storage Temperature	-13°F ~ 140°F / -25°C ~ 60°C
Humidity	5% to 95% (three-layer paint protection)
Noise	≤60dB
Cooling	Fans, Forced cooling with adjustable air speed
IP Grade	IP 20
Safety Class	I
Dimensions (L-W-D)	16.8*12.7*4.9 in / 426*322*124 mm
Weight	25.6 lbs /11.6kg

■ Non-Lithium Battery Parameters

Battery type Parameters	Sealed lead acid battery (SLD)	Colloidal lead acid battery (GEL)	Vented lead acid battery (FLD)	User-defined (USE)
Overvoltage disconnection voltage	60V	60V	60V	60V
Equalizing charge voltage	58.4V	56.8V	59.2V	40~60V (adjustable)
Boost charge voltage	57.6V	56.8V	58.4V	40~60V (adjustable)
Floating charge voltage	55.2V	55.2V	55.2V	40~60V (adjustable)
Undervoltage alarm voltage	44V	44V	44V	40~60V (adjustable)
Low voltage disconnection voltage	42V	42V	42V	40~60V (adjustable)
Discharge limit voltage	40V	40V	40V	40~60V (adjustable)
Over-discharge delay time	5S	5S	5S	1~30S (adjustable)
Equalizing charge duration	120 minutes	-	120 minutes	0~600 minutes (adjustable)
Equalizing charge interval	30 days	-	30 days	0~250 days (adjustable)
Boost charge duration	120 minutes	120 minutes	120 minutes	10~600 minutes (adjustable)

When modifying parameters in User Mode, the following rules must be followed to set parameters successfully.

1. Overvoltage Disconnect > Overvoltage Disconnect Recover \geq Equalization voltage \geq Boost voltage \geq Float voltage
2. Overvoltage Disconnect > Over Voltage Disconnect Recover
3. Low Voltage Disconnect Recover > Low Voltage Disconnect (at least 2V Smaller) < Discharge Limit Voltage
4. Undervoltage Recover > Undervoltage Alarm



If setting the Low Voltage Disconnect in User Mode, it must always be at least 2V lower than the Low Voltage Disconnect Recovery Voltage

Lithium Battery Parameters

Battery type Parameters	Ternary lithium battery (N13)	Ternary lithium battery (N14)	Lithium iron phosphate battery (L16)	Lithium iron phosphate battery (L15)	Lithium iron phosphate battery (L14)	User defined (USE)
Over Voltage Disconnect	60V	60V	60V	60V	60V	60V
Equalization Voltage	-	-	-	-	-	40~60V (adjustable)
Boost Voltage	53.2V (adjustable)	57.6V (adjustable)	56.8V (adjustable)	53.2V (adjustable)	49.2V (adjustable)	40~60V (adjustable)
Floating voltage	53.2V (adjustable)	57.6V (adjustable)	56.8V (adjustable)	53.2V (adjustable)	49.2V (adjustable)	40~60V (adjustable)
Undervoltage alarm voltage	43.6V (adjustable)	46.8V (adjustable)	49.6V (adjustable)	46.4V (adjustable)	49.2V (adjustable)	40~60V (adjustable)
Low Voltage Disconnect	38.8V (adjustable)	42V (adjustable)	48.8V (adjustable)	45.6V (adjustable)	42V (adjustable)	40~60V (adjustable)
Discharge Limit Voltage	36.4V	39.2V	46.4V	43.6V	40.8V	40~60V (adjustable)
Over- discharge Delay Time	30s (adjustable)	30s (adjustable)	30s (adjustable)	30s (adjustable)	30s (adjustable)	1~30s (adjustable)
Equalizing charge duration	-	-	-	-	-	0~600minutes (adjustable)
Equalizing charge interval	-	-	-	-	-	0~250days (adjustable)
Boost Duration	120 minutes (adjustable)	120 minutes (adjustable)	120 minutes (adjustable)	120 minutes (adjustable)	120 minutes (adjustable)	10~600 minutes (adjustable)

When modifying parameters in User Mode or Lithium, the following rules must be followed to set parameters successfully.

1. Overvoltage Disconnect > Overvoltage Disconnect Recover \geq Equalization voltage \geq Boost voltage \geq Float voltage
2. Overvoltage Disconnect > Over Voltage Disconnect Recover
3. Low Voltage Disconnect Recover > Low Voltage Disconnect (at least 2V Smaller) < Discharge Limit Voltage
4. Undervoltage Recover > Undervoltage Alarm



If setting the Low Voltage Disconnect in User Mode, it must always be at least 2V lower than the Low Voltage Disconnect Recovery Voltage.

Charging Parameters Glossary

- **Overvoltage Disconnect**—When and if the charge controller experiences a voltage higher than what is assigned, it will disconnect itself from the circuit; ceasing charge.
- **Overvoltage Recover**-- in the event a charge controller experiences an over-voltage condition set by the previous parameter, then this reconnecting parameter is put into play to direct the controller when it can connect and safely charge again. Typically over-voltage reconnection is achieved when time has passed (ex. The sun setting), or when the over-voltage condition is remedied ultimately reducing the voltage to a user defined charging voltage.
- **Equalization Voltage**-- equalization voltage is a corrective over-charge of the battery. The user should consult their battery manufacturer regarding specific battery equalization capacity. This parameter sets the equalization voltage to set the battery at when it reaches the equalization state.
- **Boost Voltage**-- users should check with their battery manufacturer for proper charging parameters. In this stage, users set the boost voltage where the battery will reach a voltage level and remain there until the battery undergoes an absorption stage.
- **Float Voltage**-- once the charge controller recognizes the set float voltage, it will commence floating. The battery is supposed to be fully charged in his state, and the charge current is reduced to maintain battery stability levels.
- **Undervoltage Recover**-- deals with the loads connected to the system. When batteries are determined to be low due to them approaching low voltage disconnect, then the loads will be shut off to give the batteries time to recover. This parameter sets the controller to shut off the loads until it can reach the low voltage reconnect stage.
- **Undervoltage Alarm**-- this parameter deals with the batteries themselves approaching the under-voltage recovery state. The user should minimize loads before the charge controller approaches a level where it will do this automatically to protect the battery from discharging.
- **Low Voltage Recover**-- parameter allows loads connected to the system will be able to operate (not fully) again.
- **Low-voltage disconnect**-- prevents over-discharge of the batteries by automatically disconnecting any loads. This extends battery life and is the precedent to being in an under-voltage state, recovering from the undervoltage state, and finally reconnecting to normal operational state.
- **Discharging limit Voltage**-- This parameter ensures that the controller does not exceed the default or assigned parameter before needing to be charged again. This is put into play to optimize and extend the battery life by going with a higher voltage. The lower the discharge limit voltage the more negative effect on battery efficiency.

This equipment has been tested and found to comply with the limits for a class B digital device, pursuant to part 15 of the FCC Rules. These limits are designed to provide reasonable protection against harmful interference in a residential installation. This equipment generates, uses and can radiate radio frequency energy and if not installed and used in accordance with the instructions, may cause harmful interference to radio communications. However, there is no guarantee that interference will not occur in a particular installation. If this equipment does cause harmful interference to radio or television reception, which can be determined by turning the equipment off and on, the user is encouraged to try to correct the interference by one or more of the following measures:

- Reorient or relocate the receiving antenna.
- Increase the separation between the equipment and receiver.
- Connect the equipment into an outlet on a circuit different from that to which the receiver is connected.
- Consult the dealer or an experienced radio/TV technician for help.

This device complies with Part 15 of the FCC Rules. Operation is subject to the following two conditions:

(1) this device may not cause harmful interference, and (2) this device must accept any interference received, including interference that may cause undesired operation.